

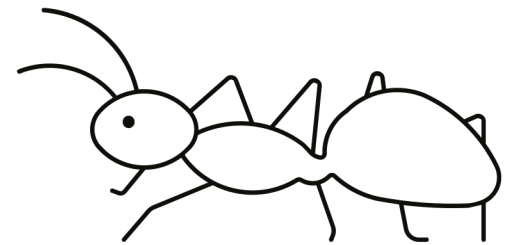

Angielskie Abecadło
Z KOLOROWANIEM

*Color the pictures that begin with the
sound of the letter A*

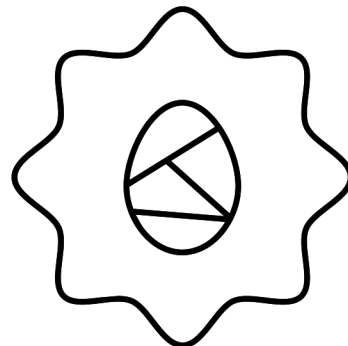
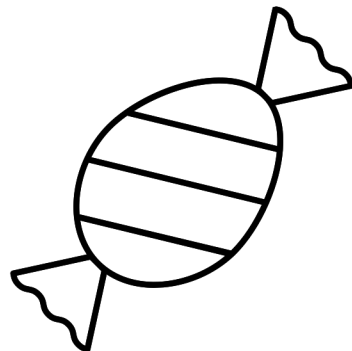
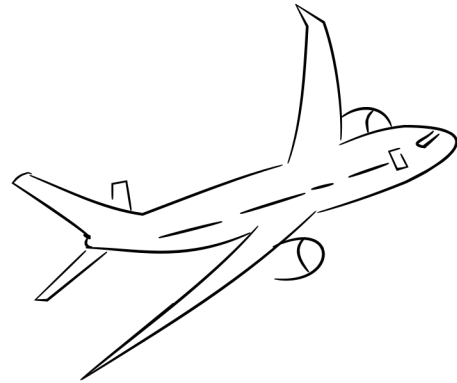
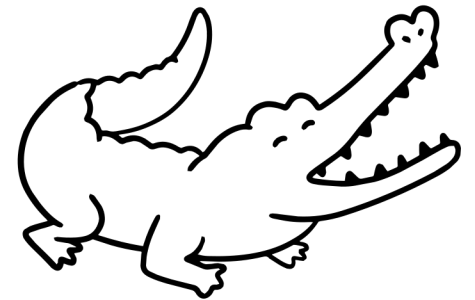
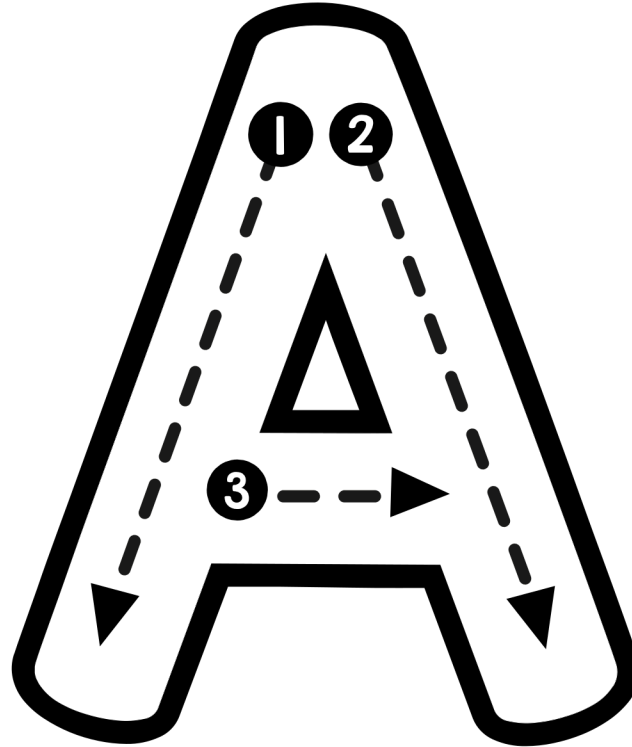
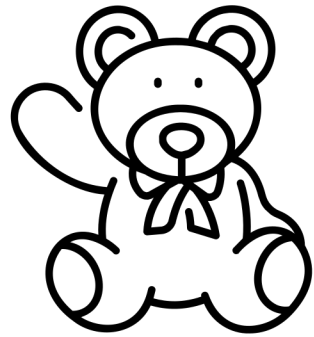
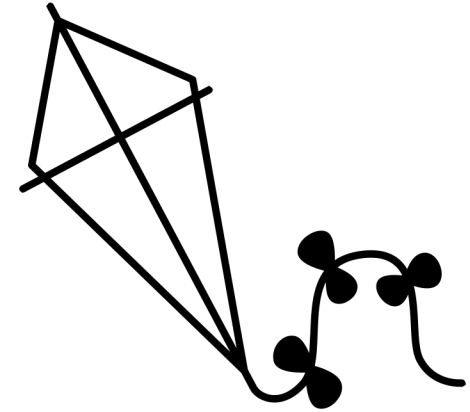
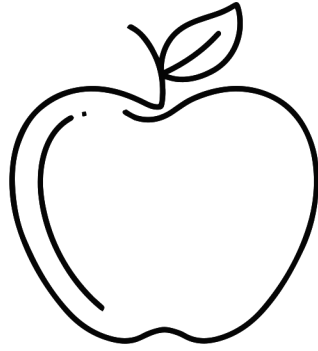

*Color the pictures that begin with the
sound of the letter B*

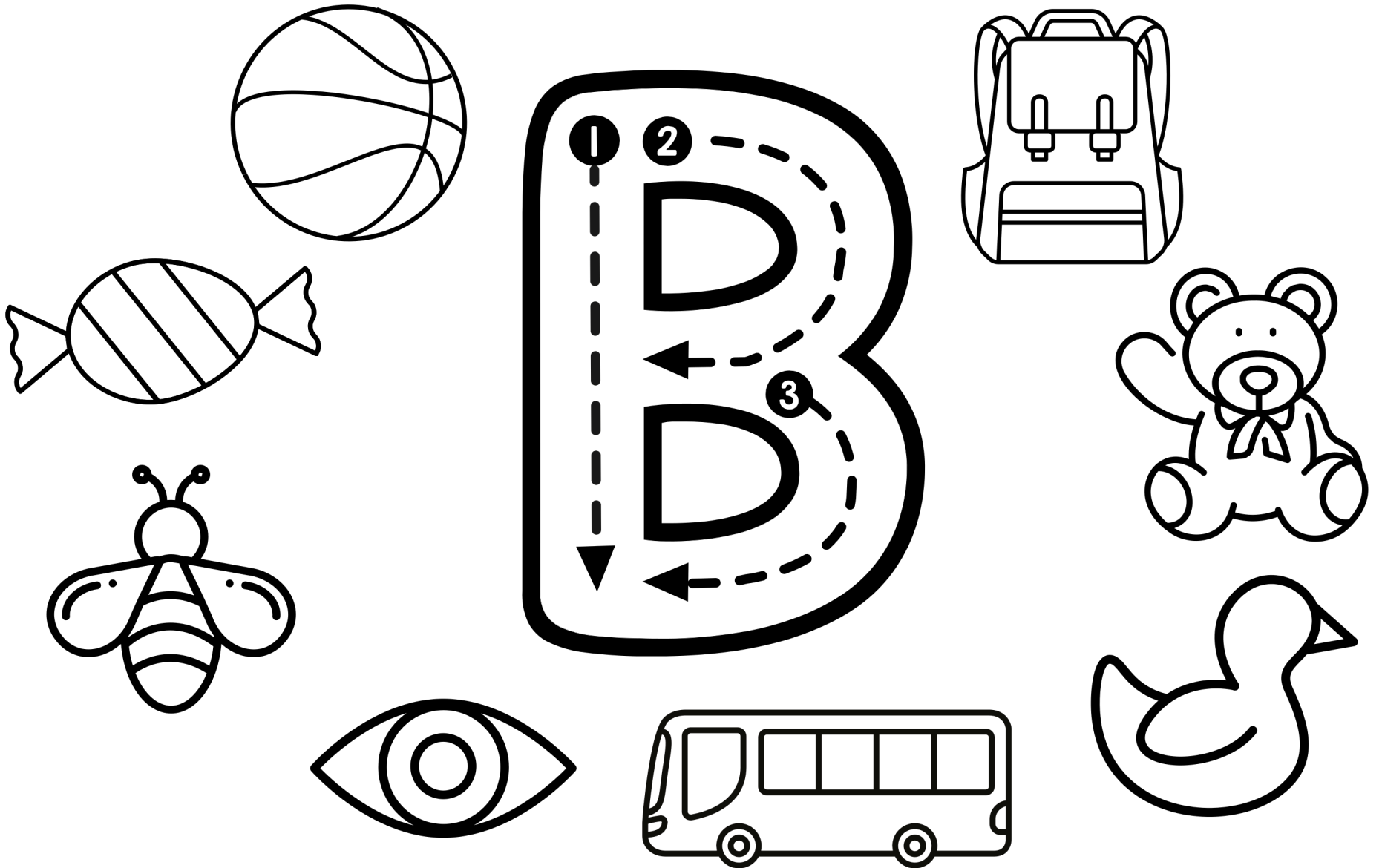

*Color the pictures that begin with the
sound of the letter C*

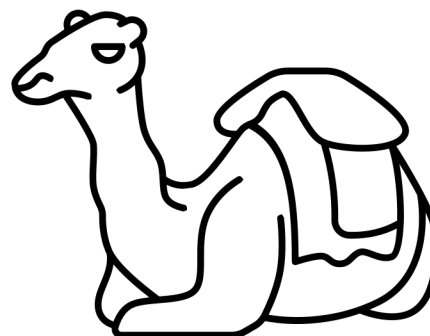
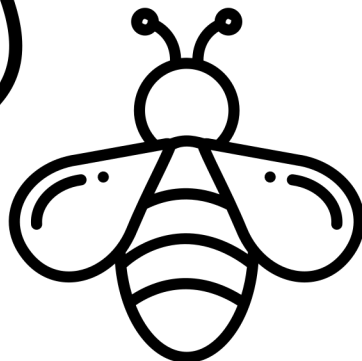
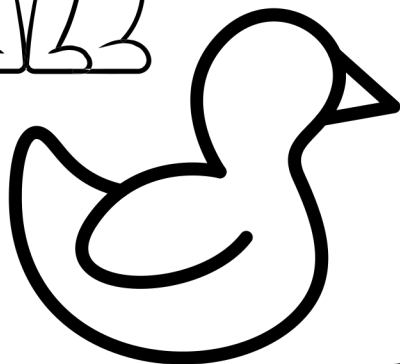
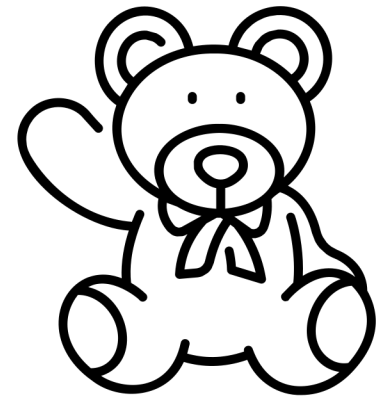
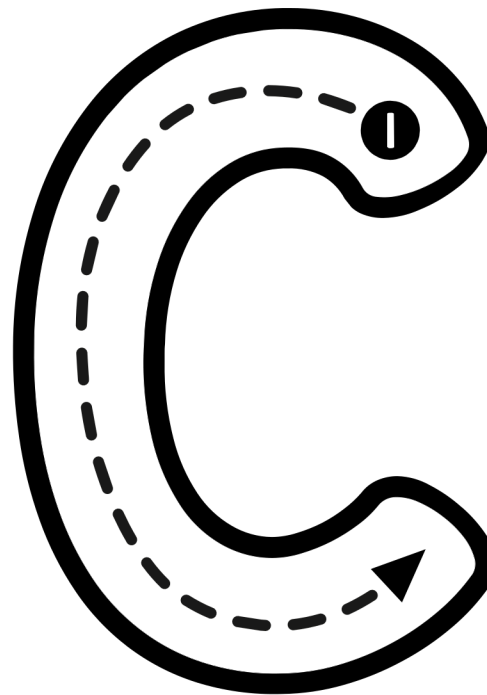
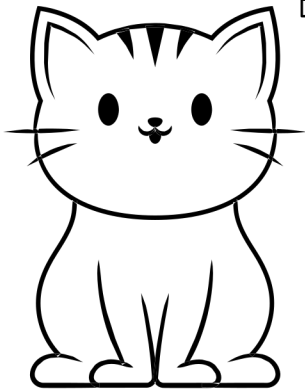
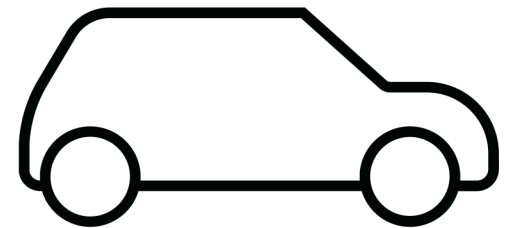
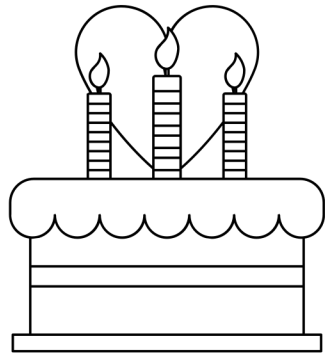

*Color the pictures that begin with the
sound of the letter D*

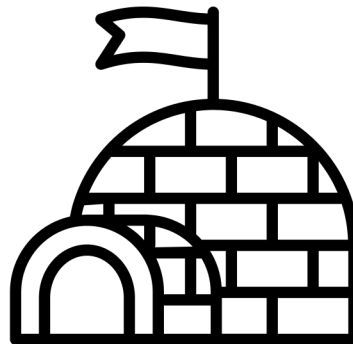
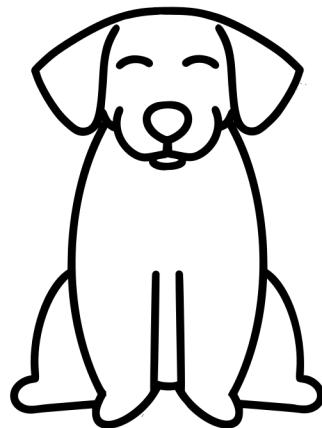
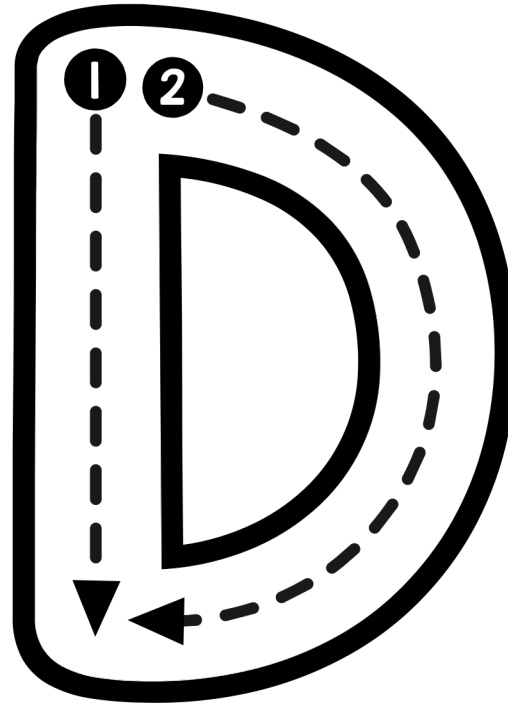
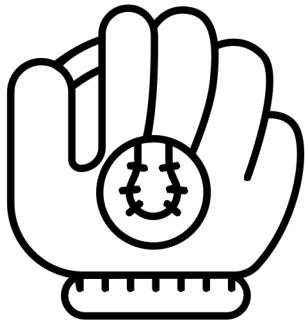
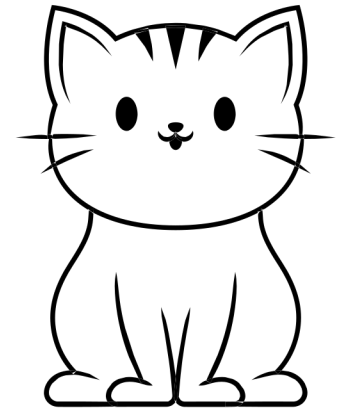
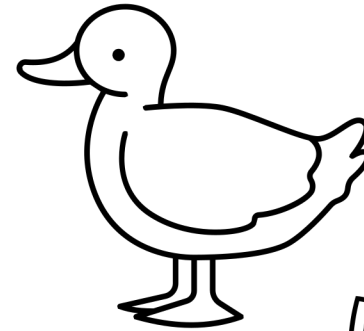
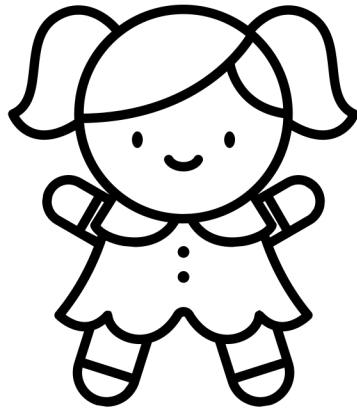

*Color the pictures that begin with the
sound of the letter E*

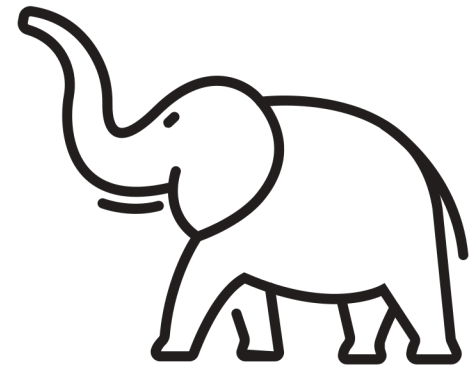
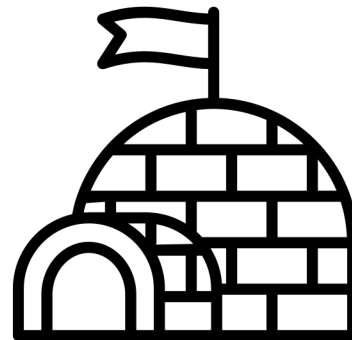
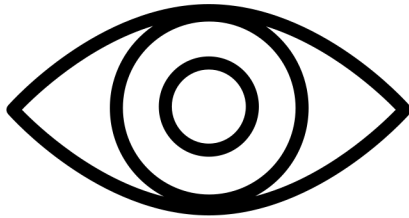
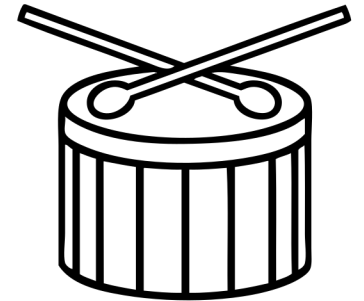
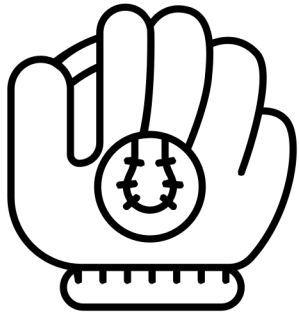
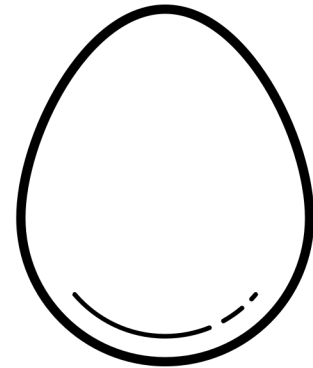
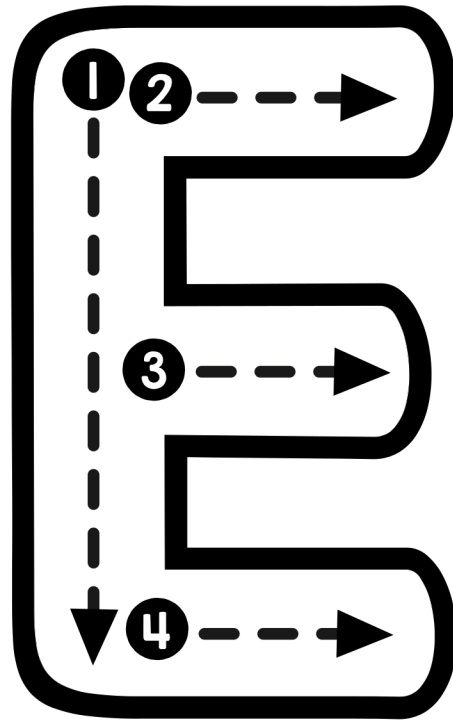

*Color the pictures that begin with the
sound of the letter F*

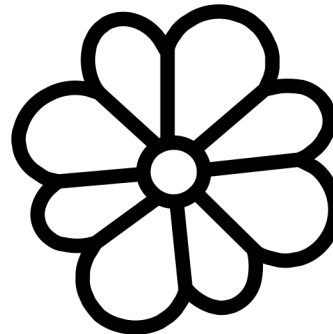
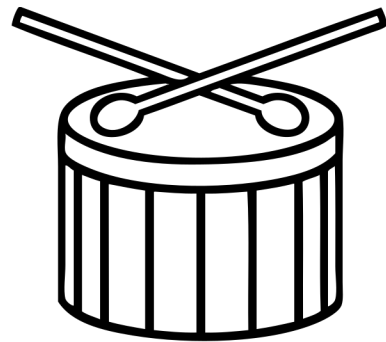
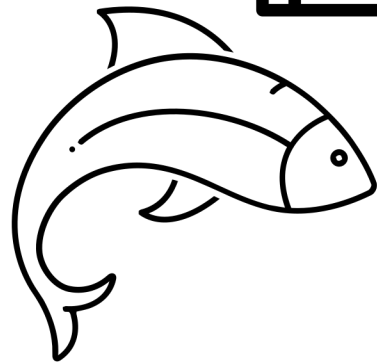
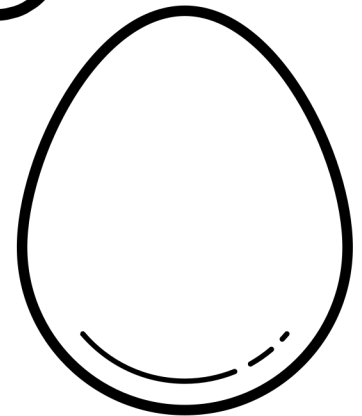
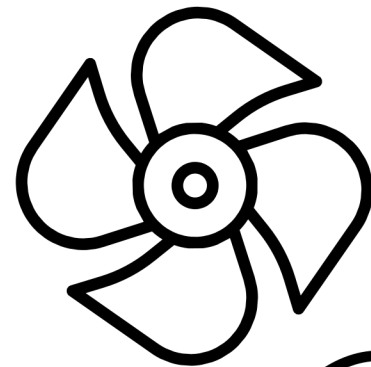
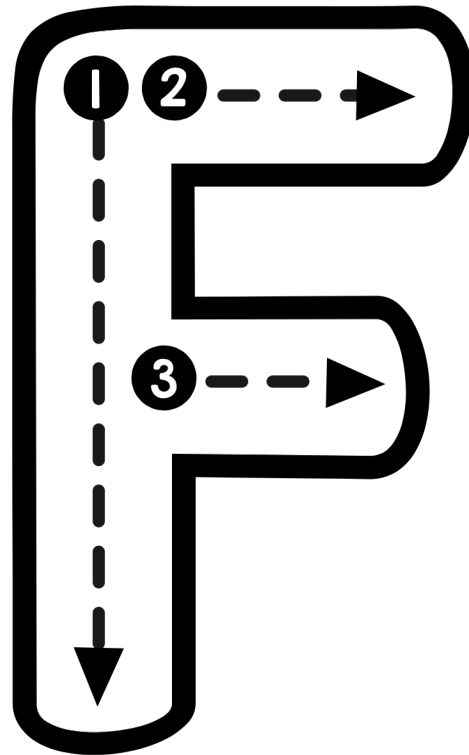
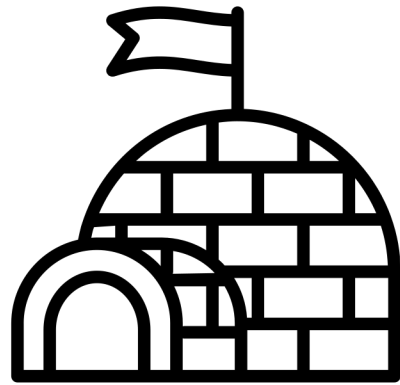

*Color the pictures that begin with the
sound of the letter G*



*Color the pictures that begin with the
sound of the letter H*

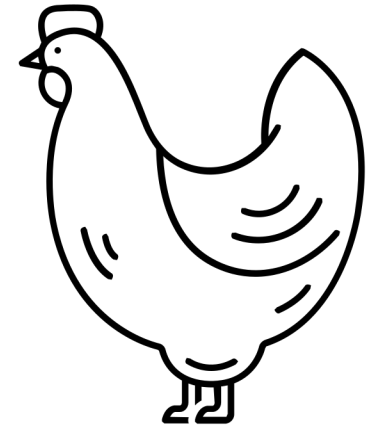
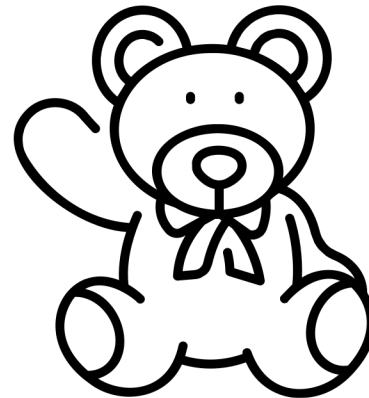
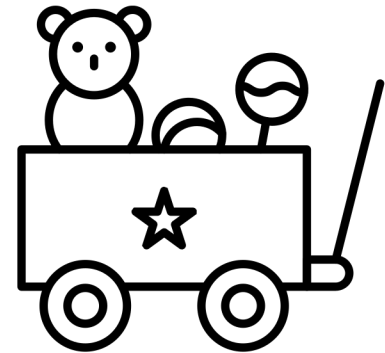
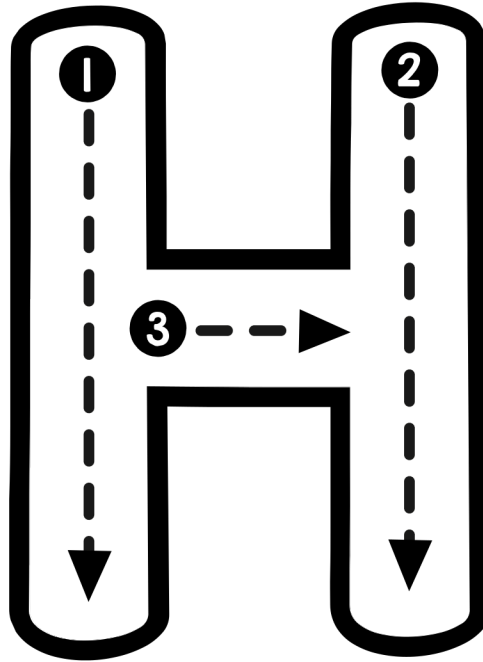
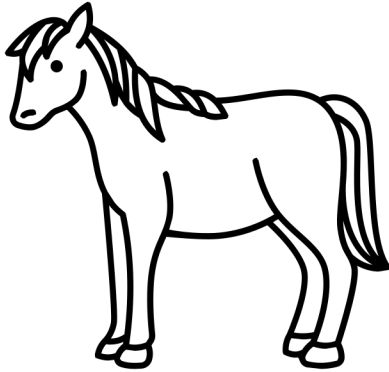

Color the pictures that begin with the sound of the letter l

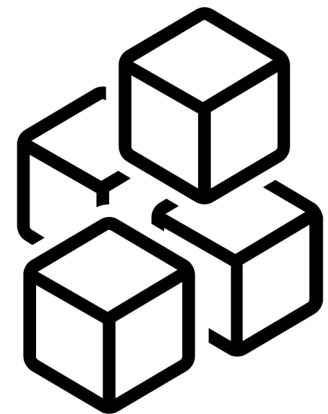
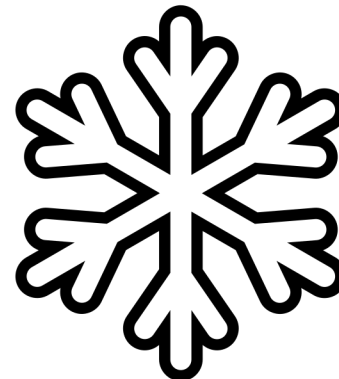
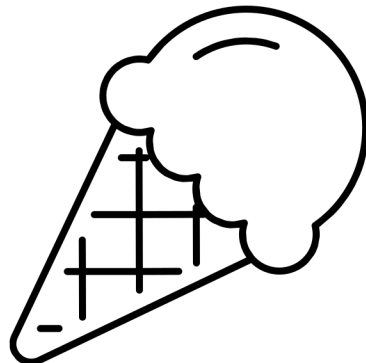
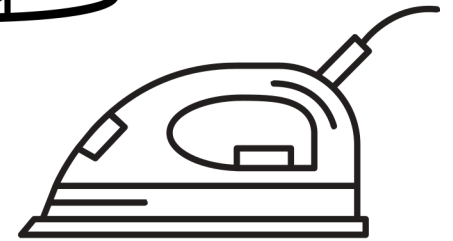
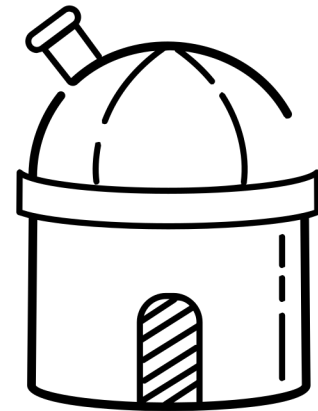
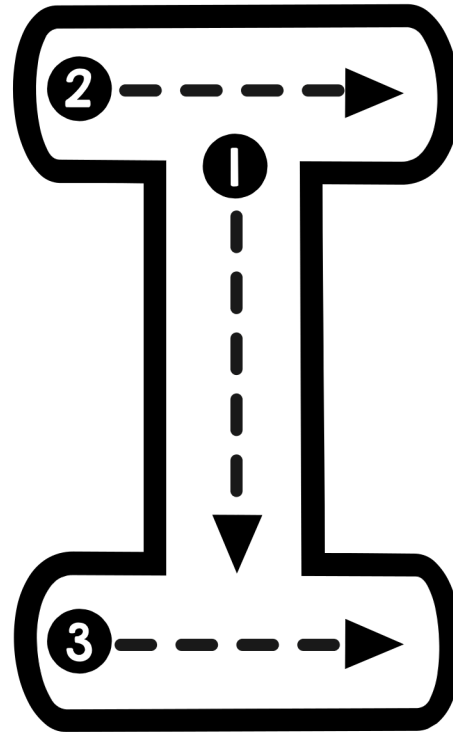
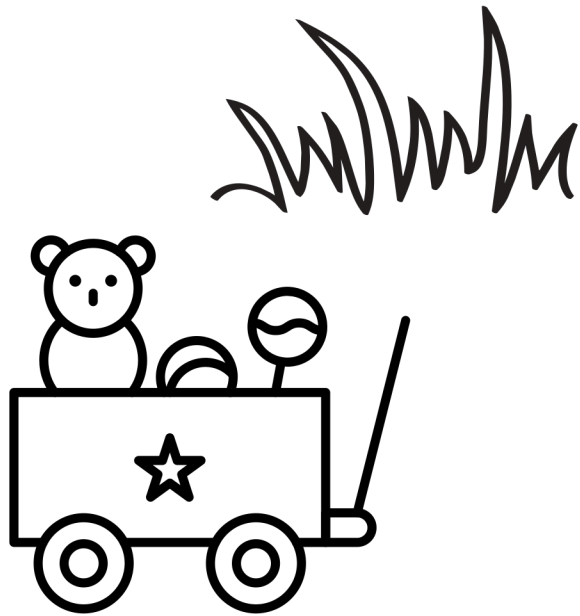

*Color the pictures that begin with the
sound of the letter J*

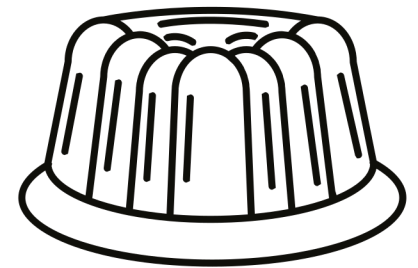
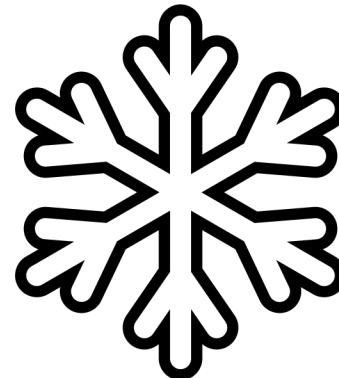
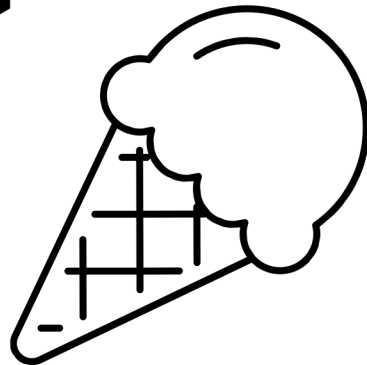
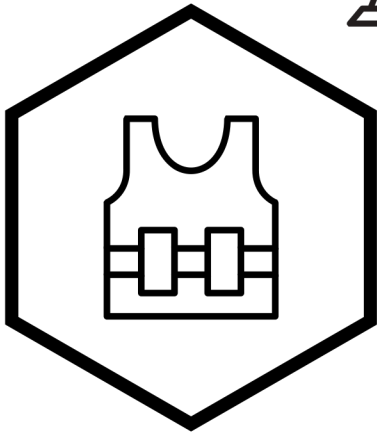
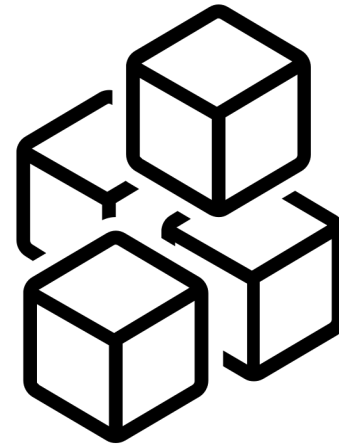
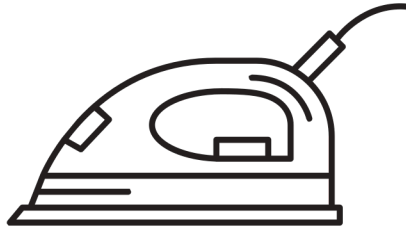
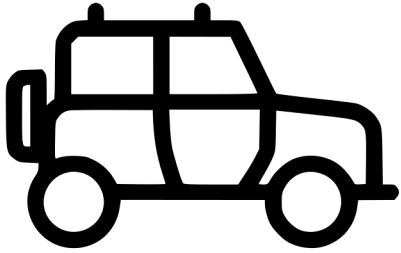

*Color the pictures that begin with the
sound of the letter K*

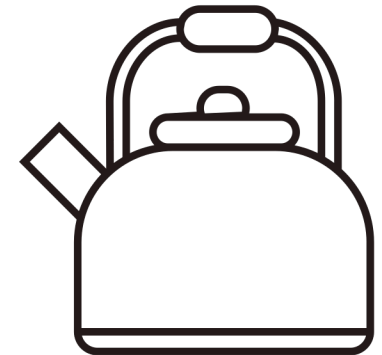
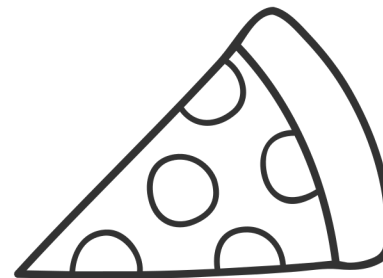
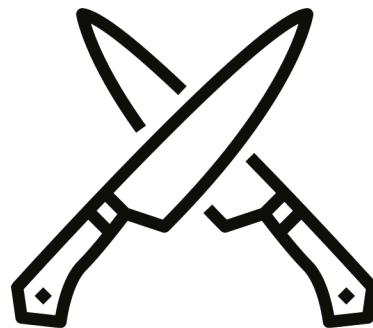
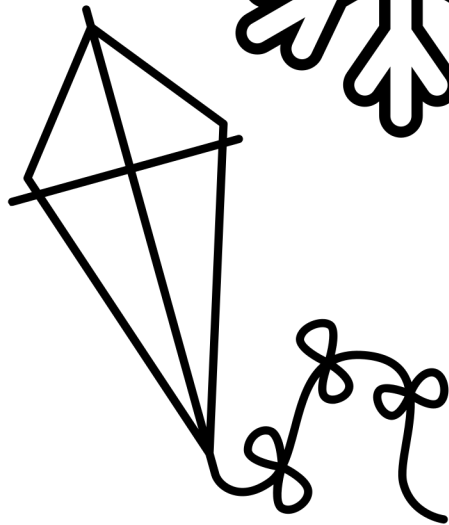
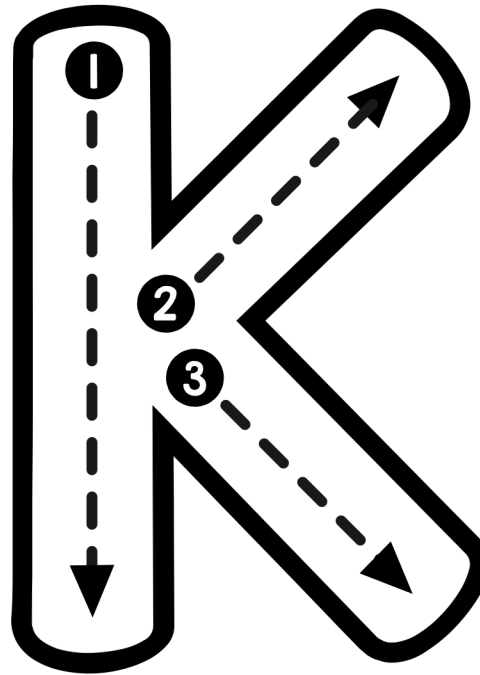
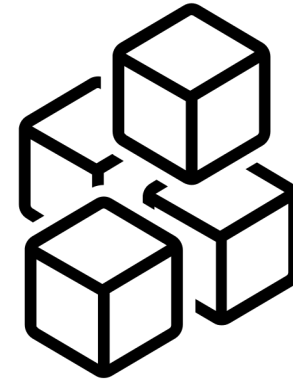
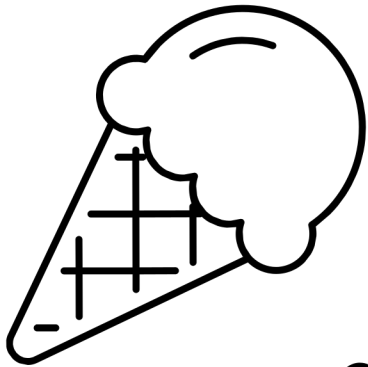

*Color the pictures that begin with the
sound of the letter L*

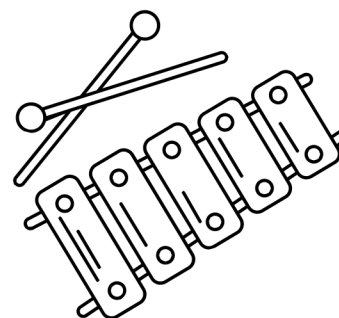
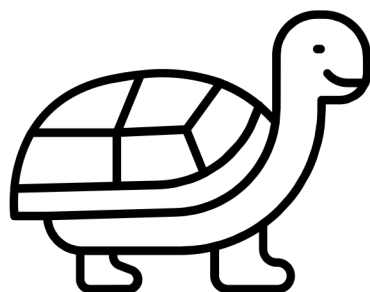
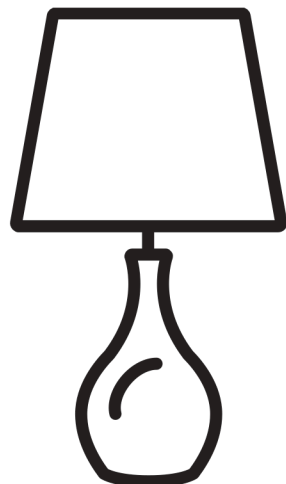
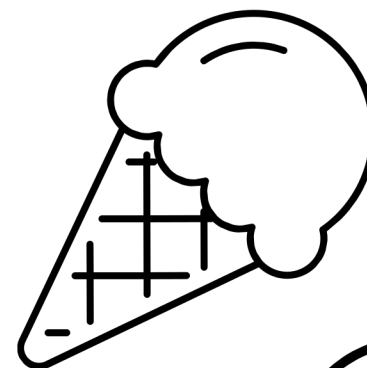
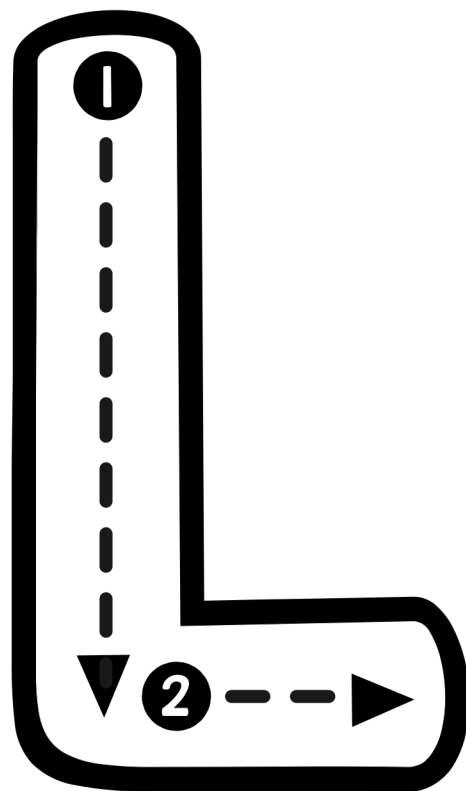
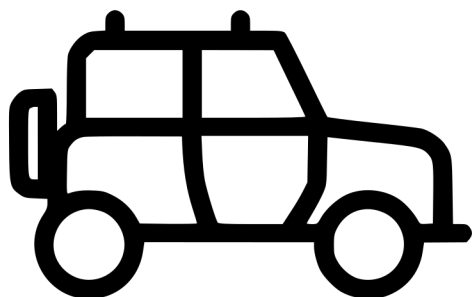
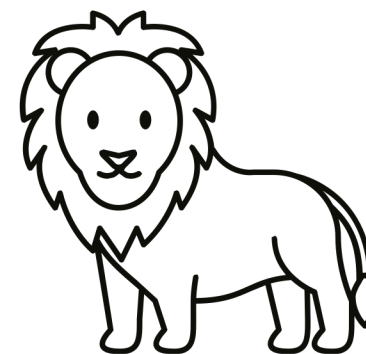
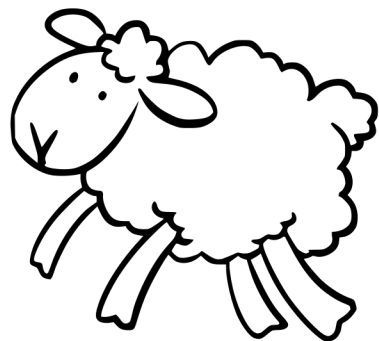

*Color the pictures that begin with the
sound of the letter M*

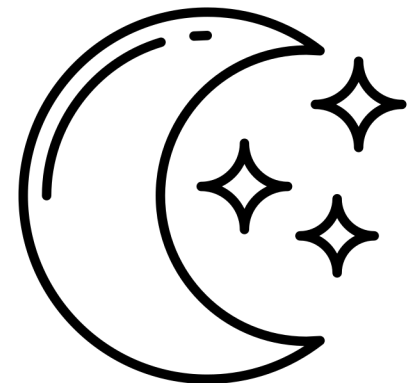
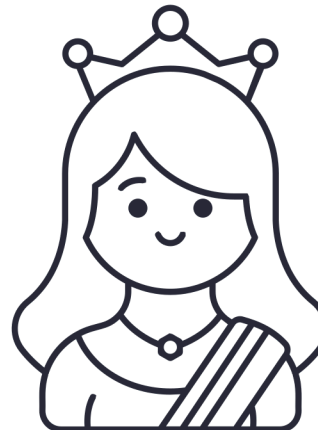
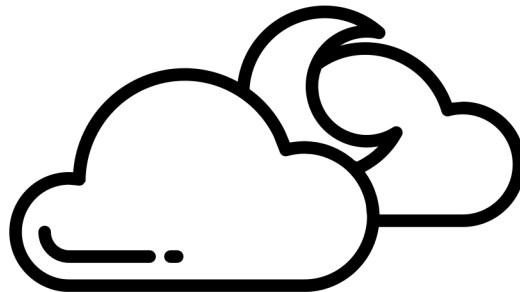
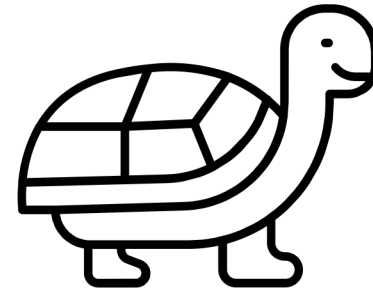
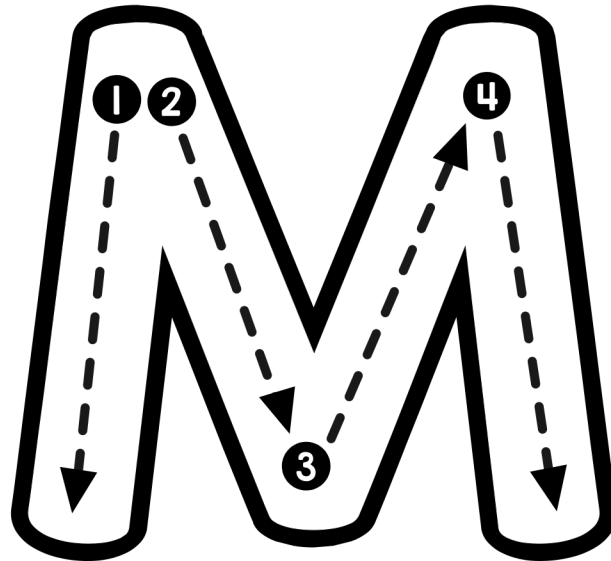
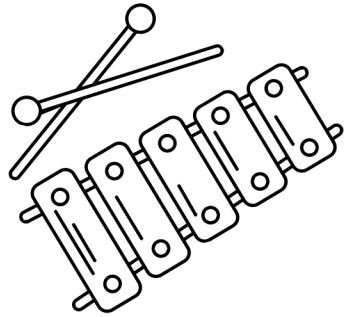
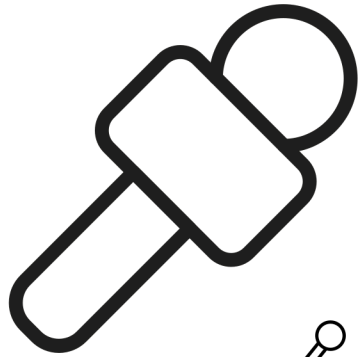

*Color the pictures that begin with the
sound of the letter N*

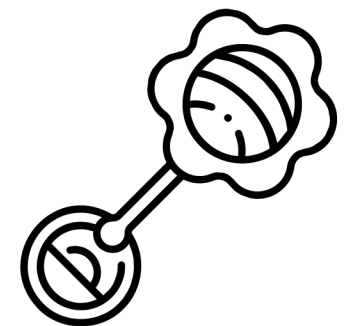
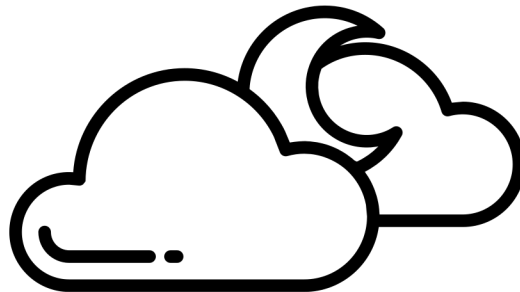
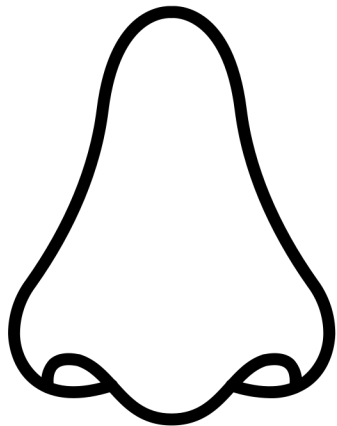
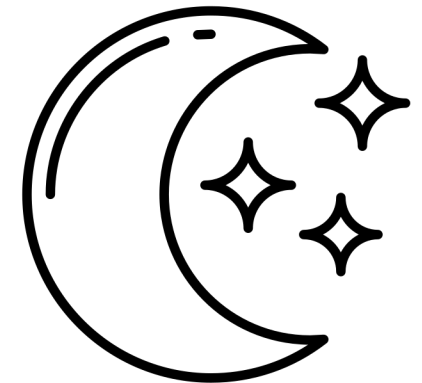
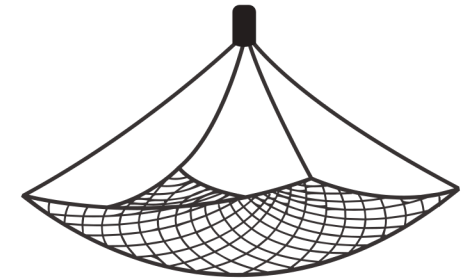
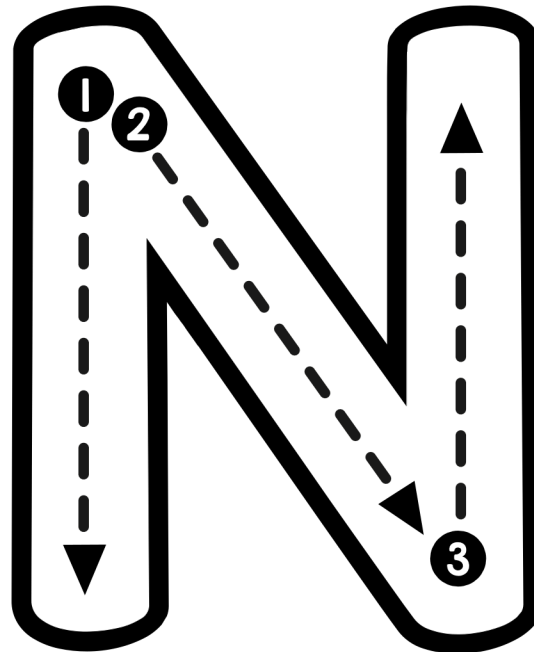
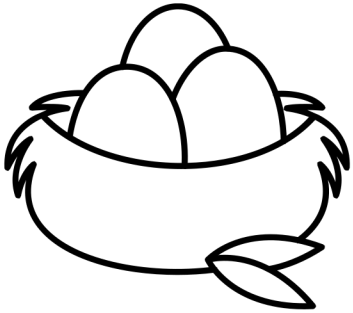

*Color the pictures that begin with the
sound of the letter O*

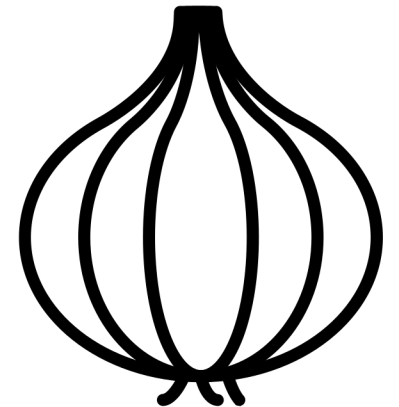
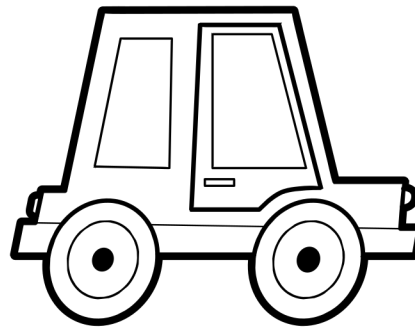
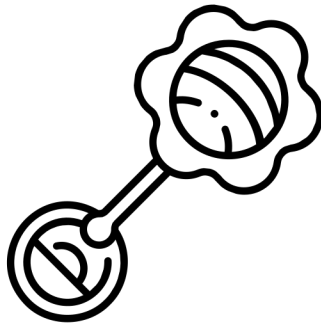
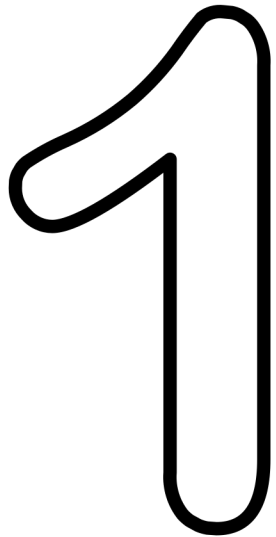
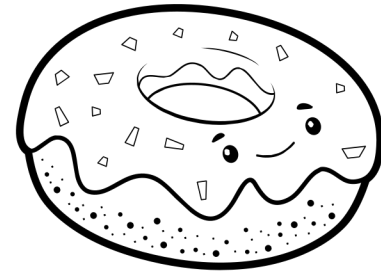
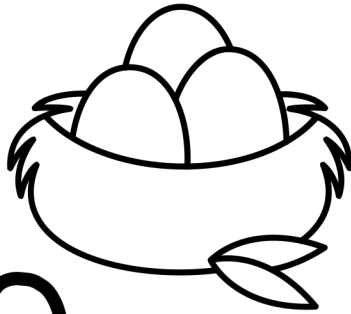
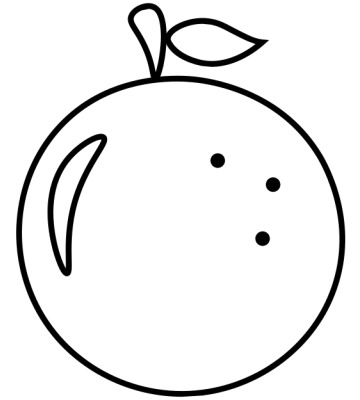
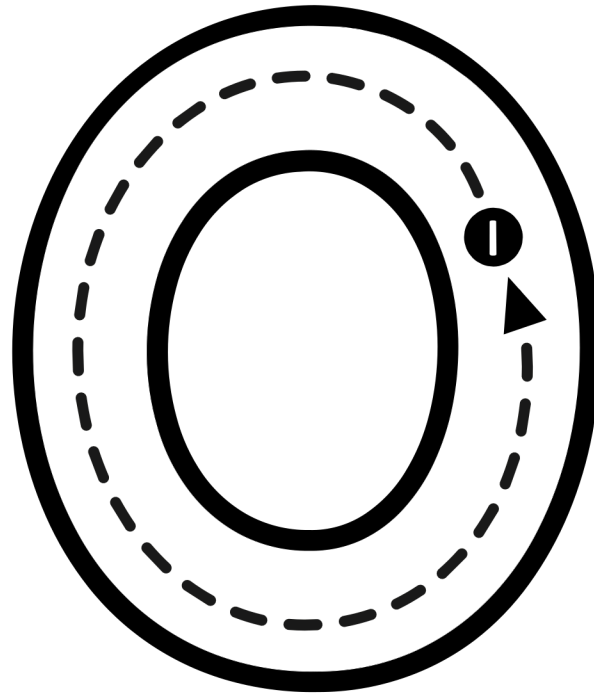
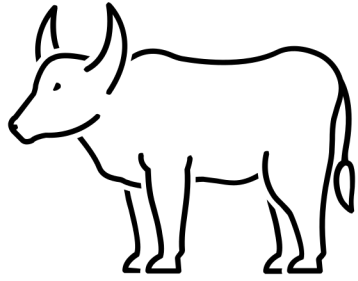

*Color the pictures that begin with the
sound of the letter P*

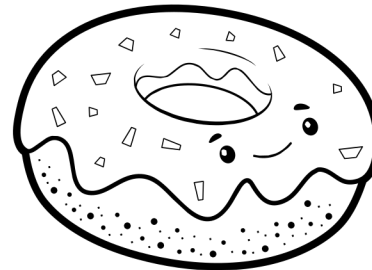
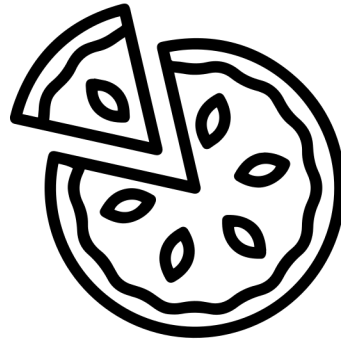
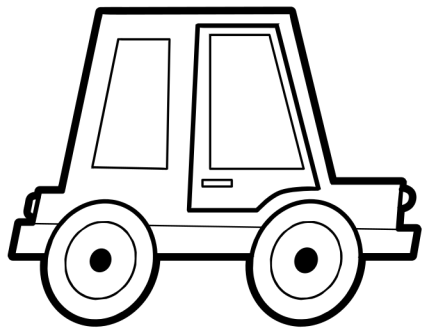
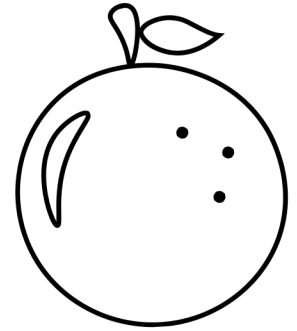
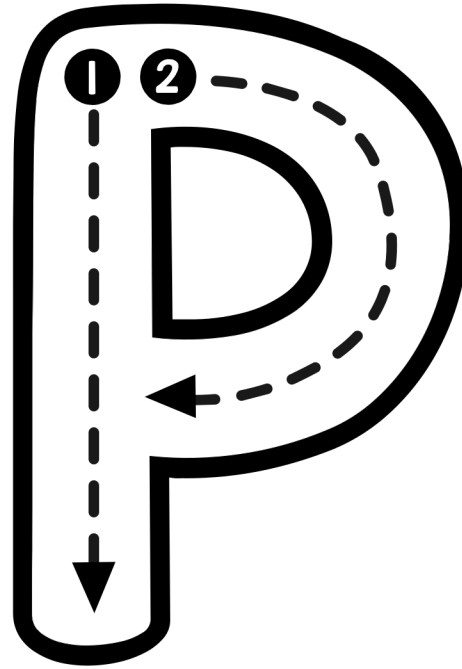
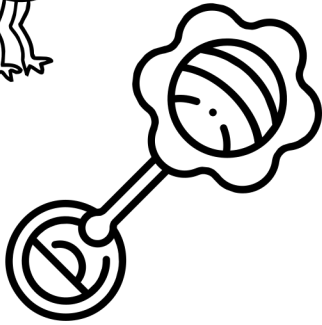
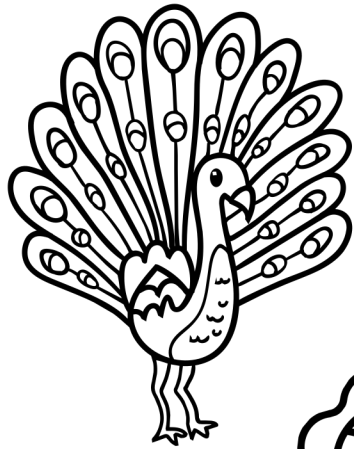

*Color the pictures that begin with the
sound of the letter Q*

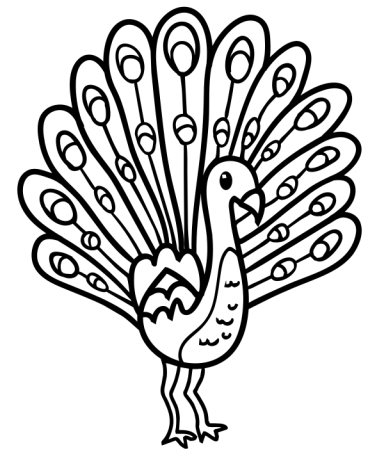
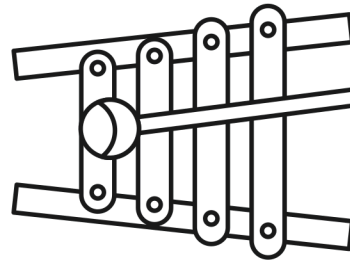
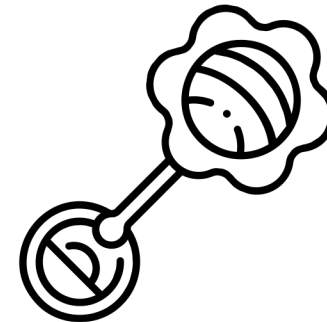
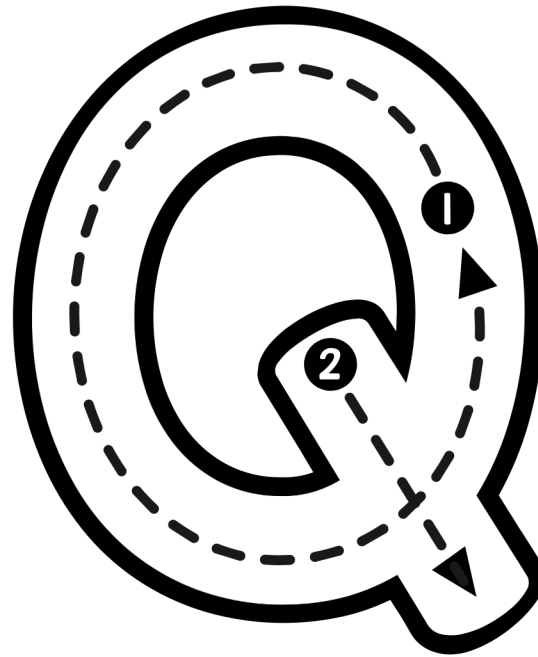
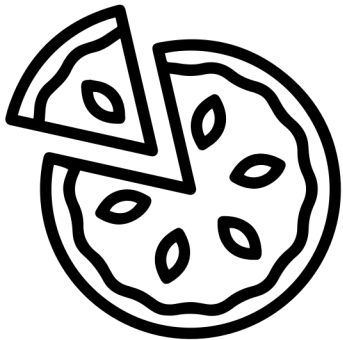
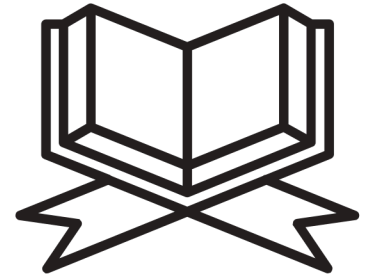
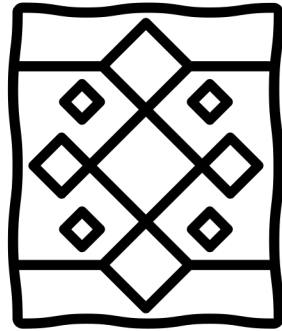

*Color the pictures that begin with the
sound of the letter R*

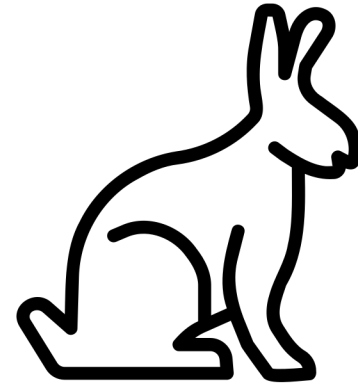
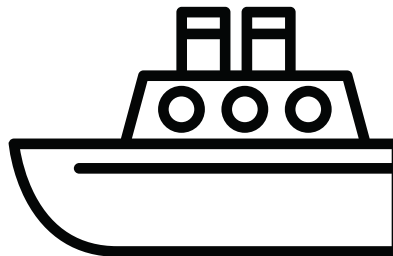
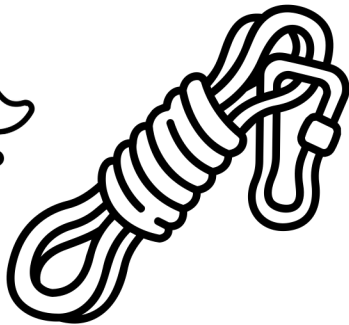
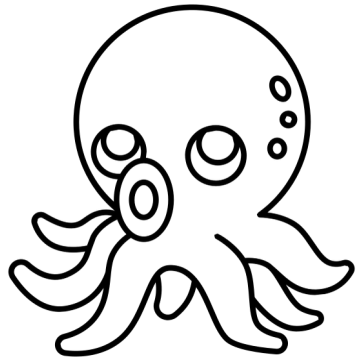
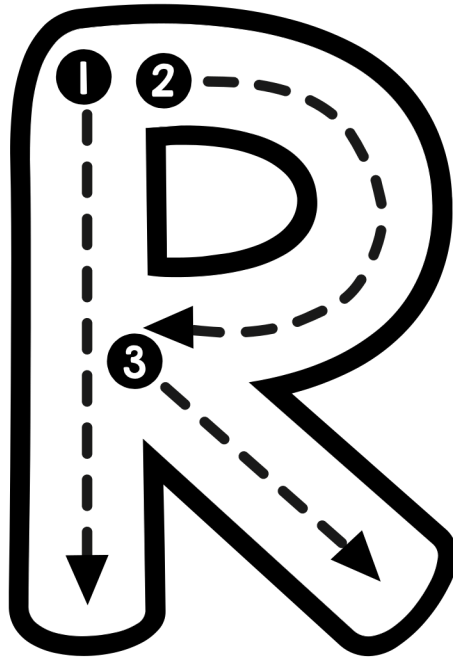
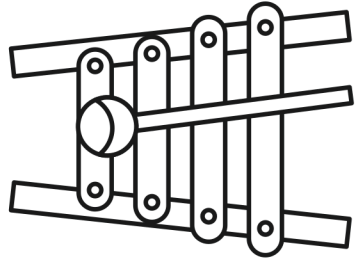

*Color the pictures that begin with the
sound of the letter S*

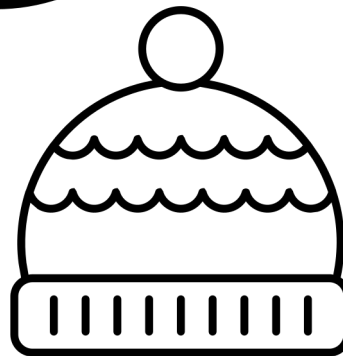
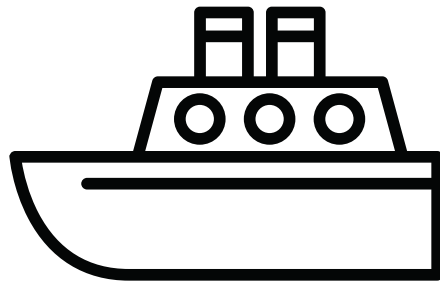
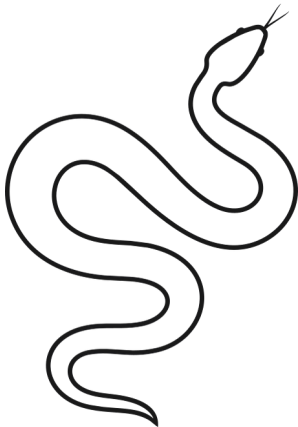
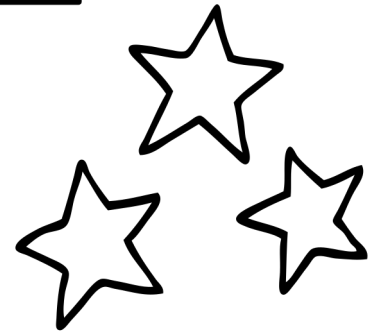
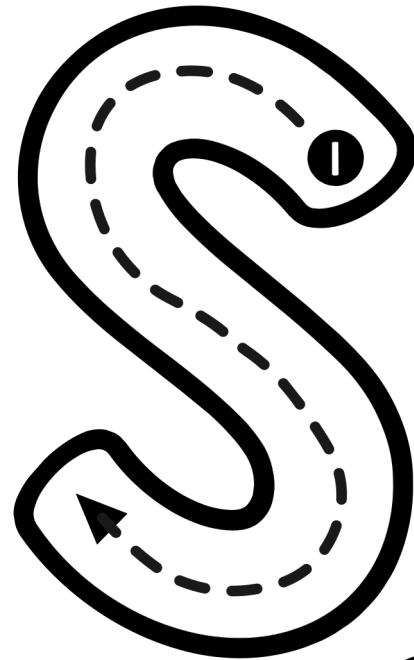
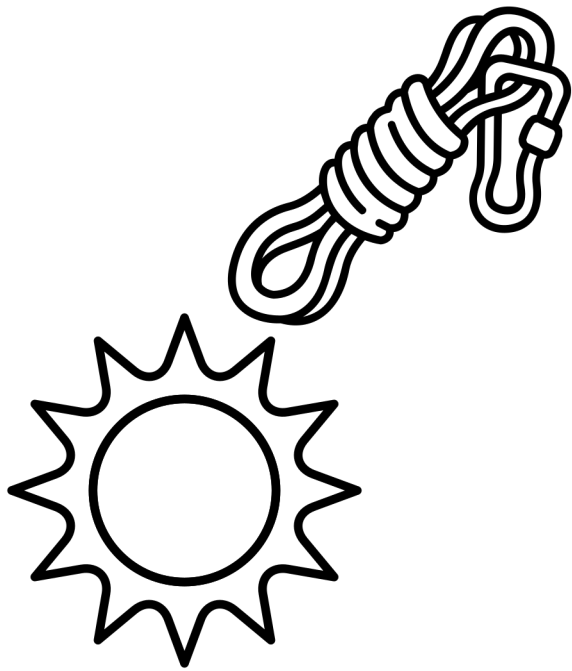

*Color the pictures that begin with the
sound of the letter T*

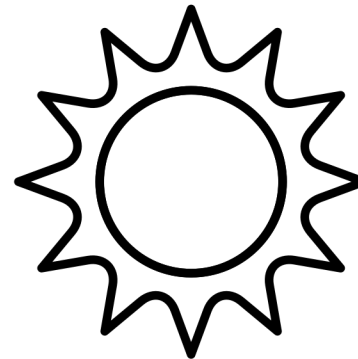
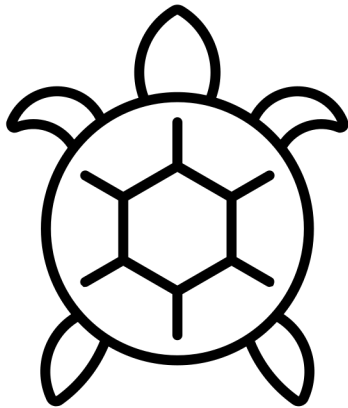
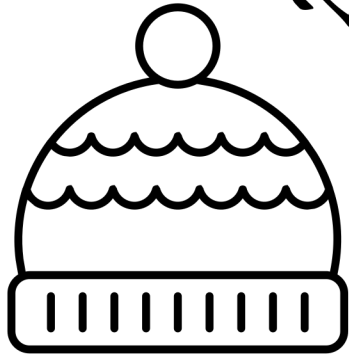
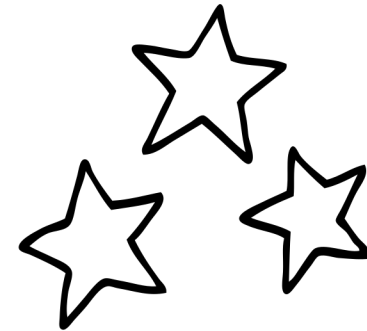
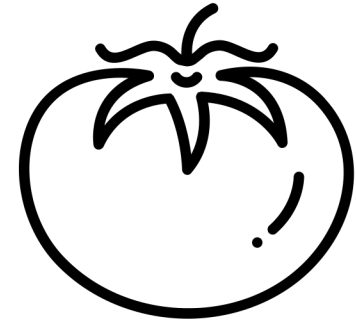
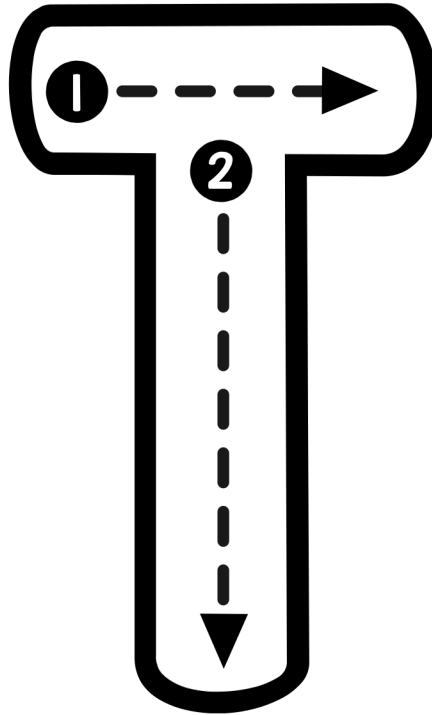

*Color the pictures that begin with the
sound of the letter U*

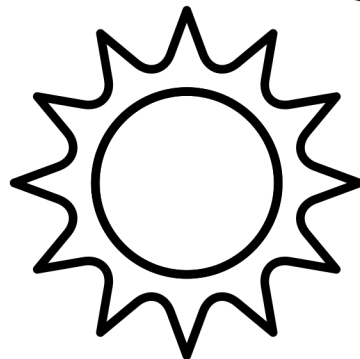
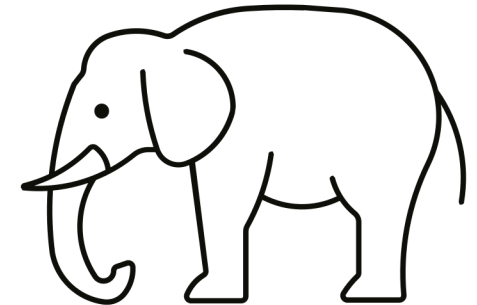
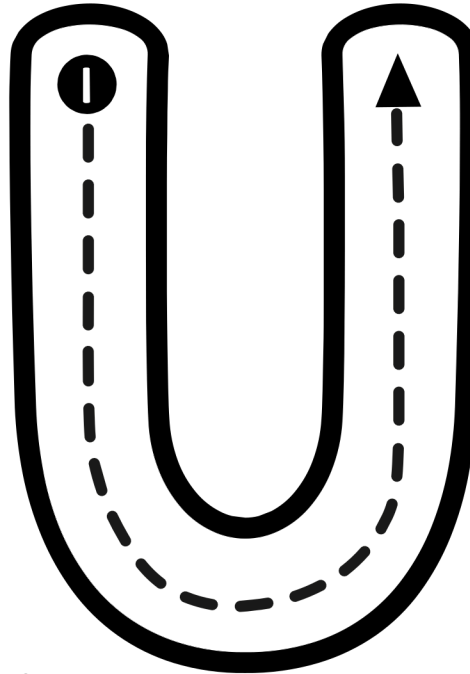

*Color the pictures that begin with the
sound of the letter V*

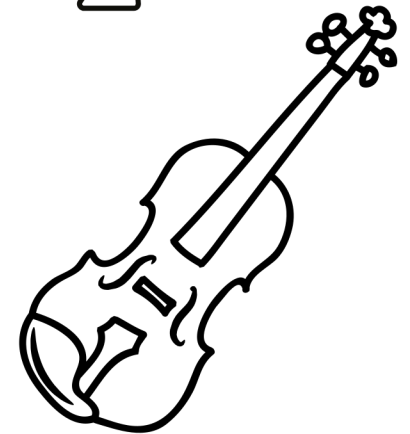
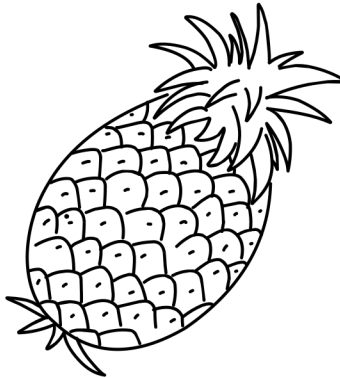
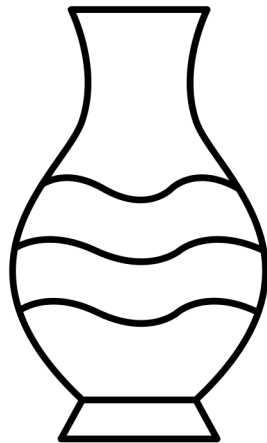
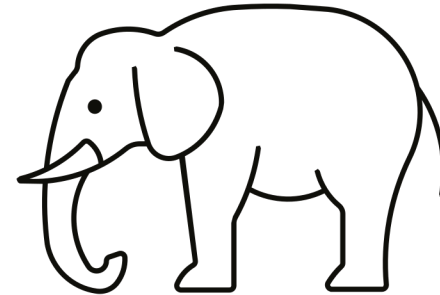
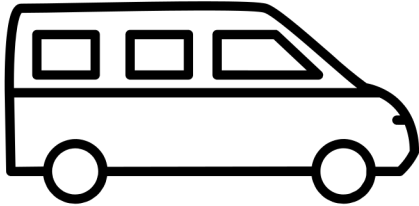
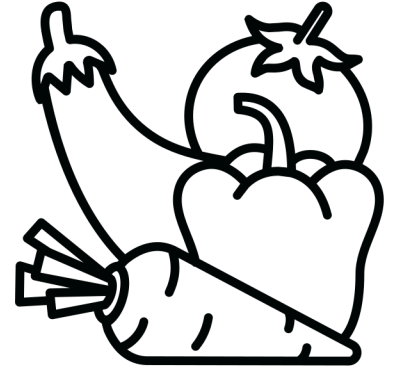
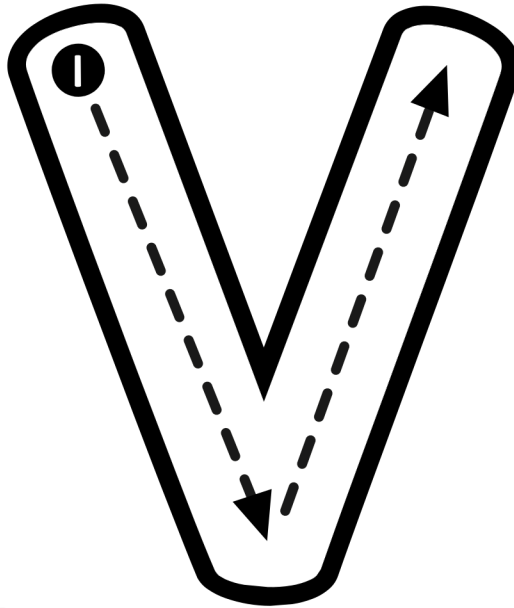
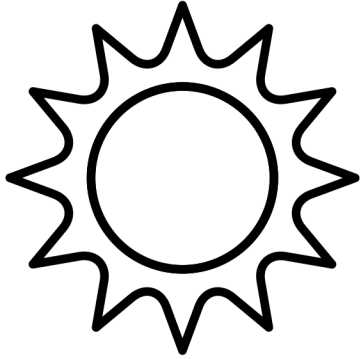

*Color the pictures that begin with the
sound of the letter W*

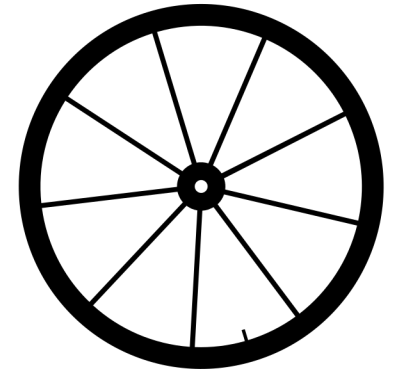
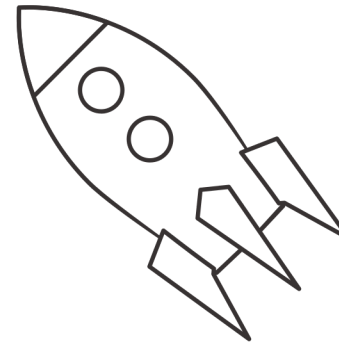
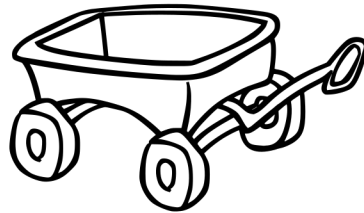
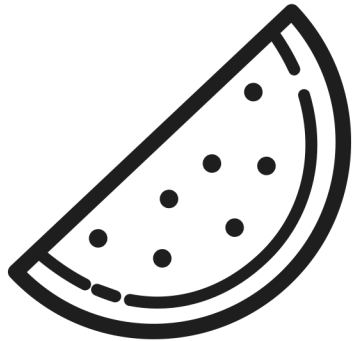
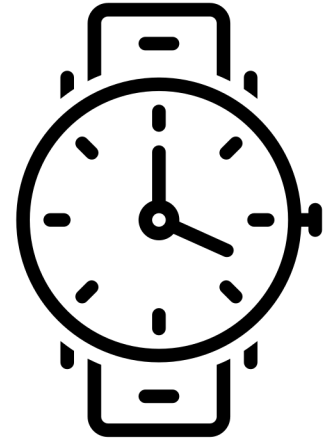
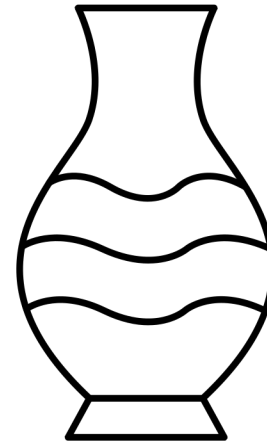
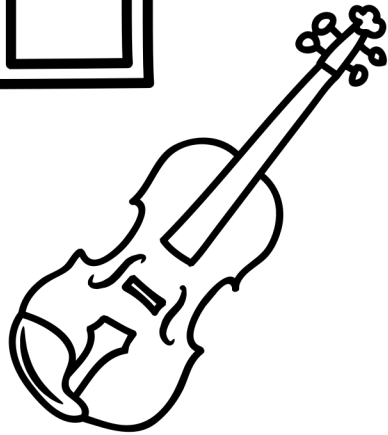
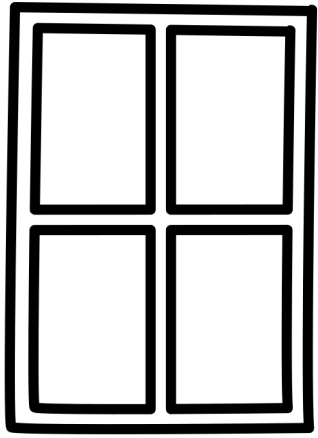

*Color the pictures that begin with the
sound of the letter X*

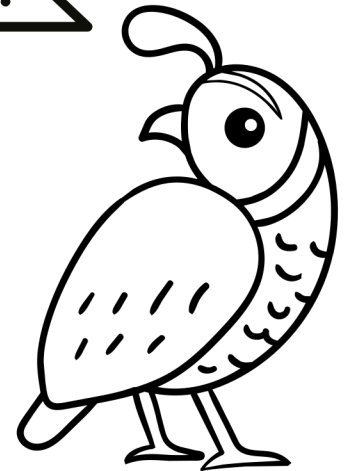
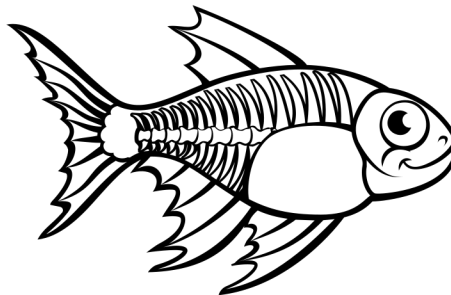
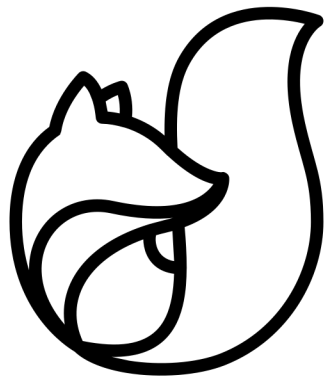
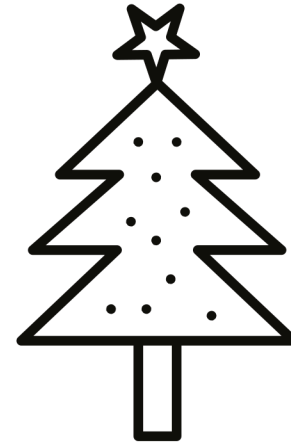
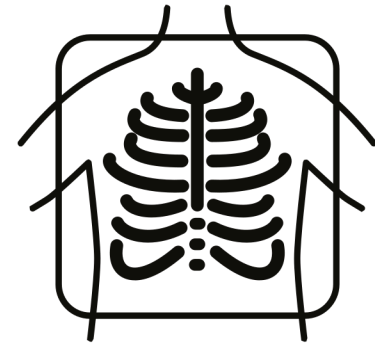
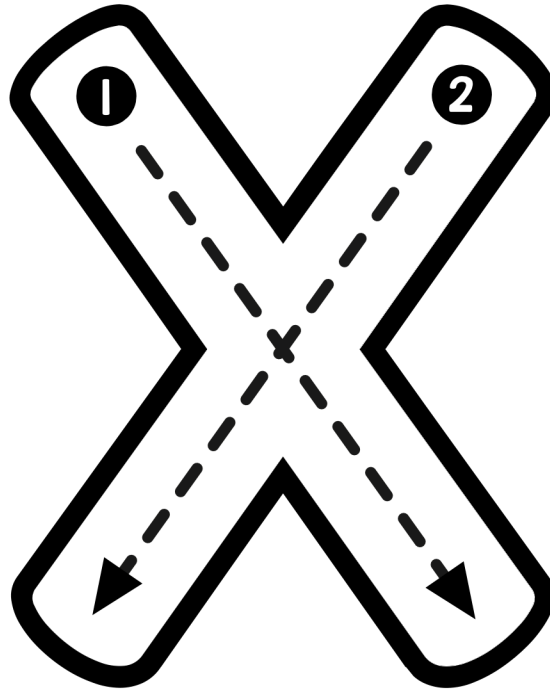
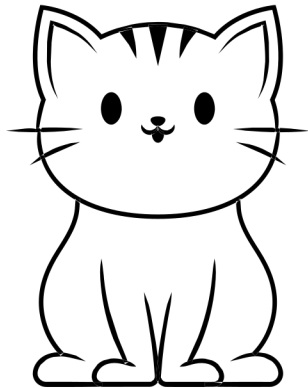
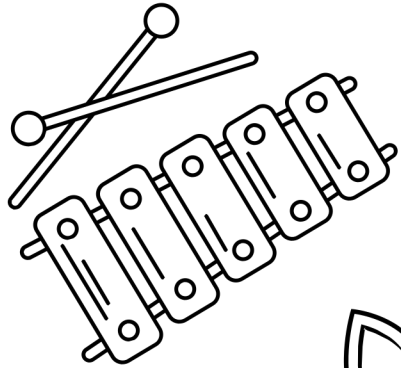

*Color the pictures that begin with the
sound of the letter Y*

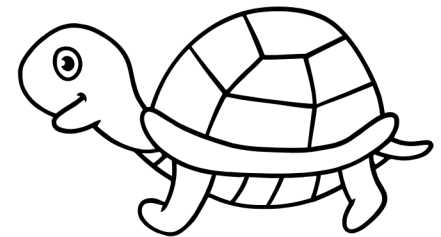
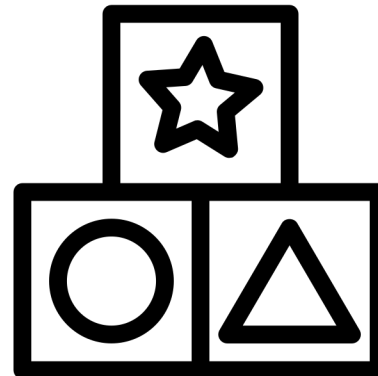
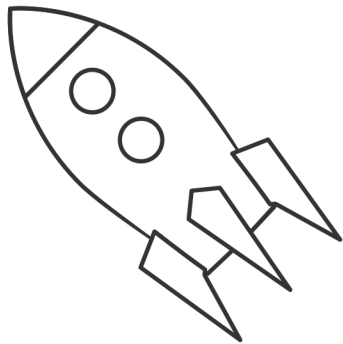
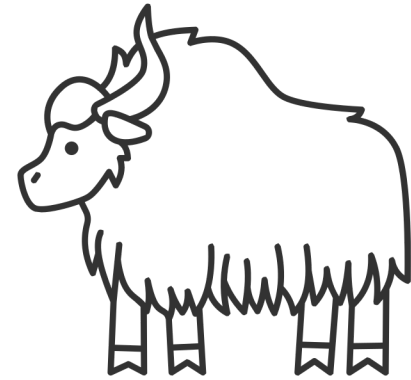
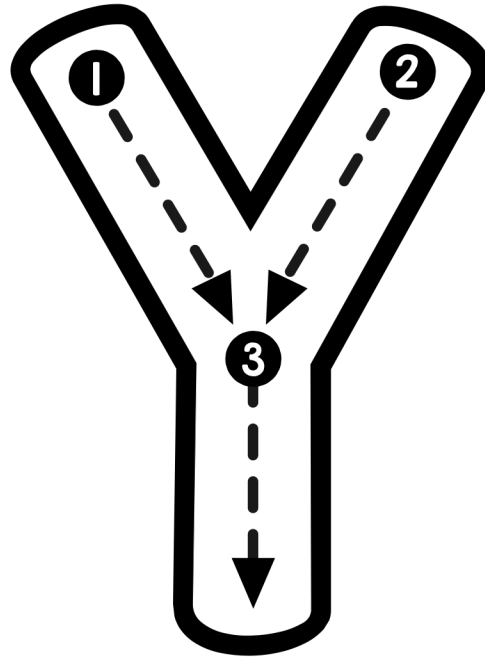
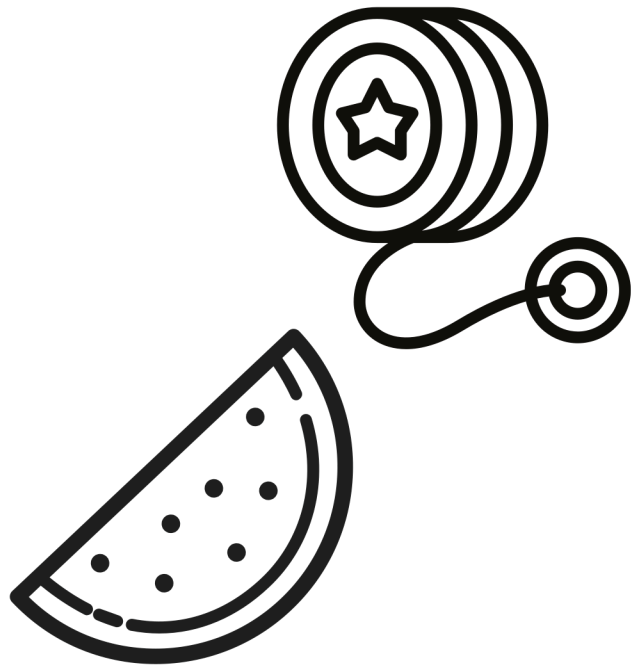

*Color the pictures that begin with the
sound of the letter Z*

